



The Lur collection is the result of a collaboration between Alki and the local ceramic expert Goicoechea. Combining the knowledge of our mutual favourite materials, wood and terracotta, Lur covers different functions. The Lur flowerpots are available in 3 different sizes to participate in the creation of an indoor vegetable atmosphere.

CATEGORY:

Props

ENVIRONMENT:

Indoor

APPLICATIONS:

- CHR
- Public
- Office
- Home

WEIGHT: 18,4 kg

MATERIALS:

Terracotta planters with solid oak top, matt varnish finishing coat. The interior pot diam 130 mm is included.

MADE TO ORDER: Finishes page 2

ACCESSORIES: No

ASSEMBLED PRODUCT: Yes

REMOVABLE PRODUCT: No

CLEANING AND CARE INSTRUCTIONS:

Dry cloth. To avoid aerosol and spray products with silicone.

DOWNLOADS:

3D and 2D files are available at alki.fr – images bank section.

DIMENSIONS :

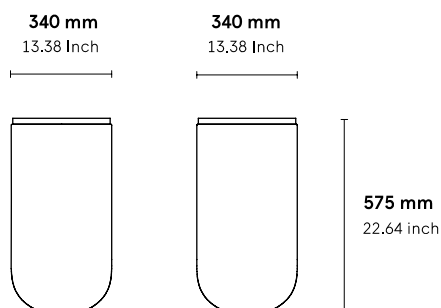

Non contractual document - modifiable without previous notice.

Finishes

Wood



Natural Oak

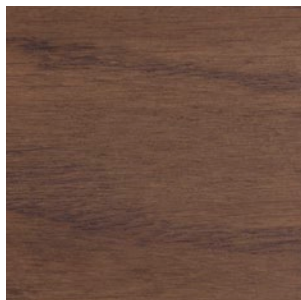

Ash Grey Oak



Tourbe Oak



Carbon Oak

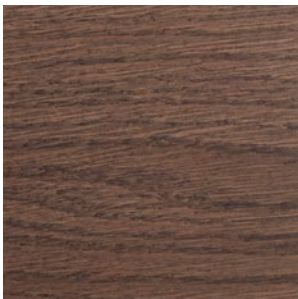

Walnut Stained Oak



White Stained Oak

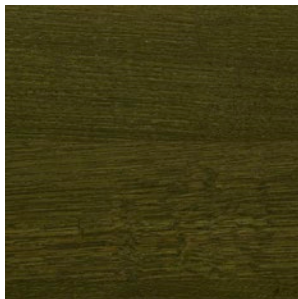

Green Z1 Oak Stain

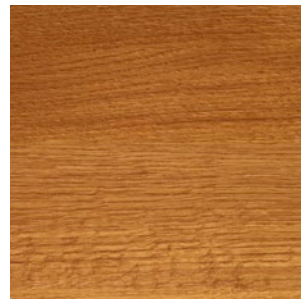

Orange 19 Oak Stain

Terracotta

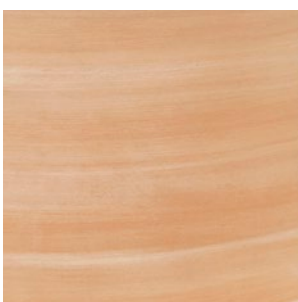

Lur Collection

Design by Iratzoki Lizaso

TABLES

Bistrot Tables

Bistro Tables

ORGANIZATION

Pots

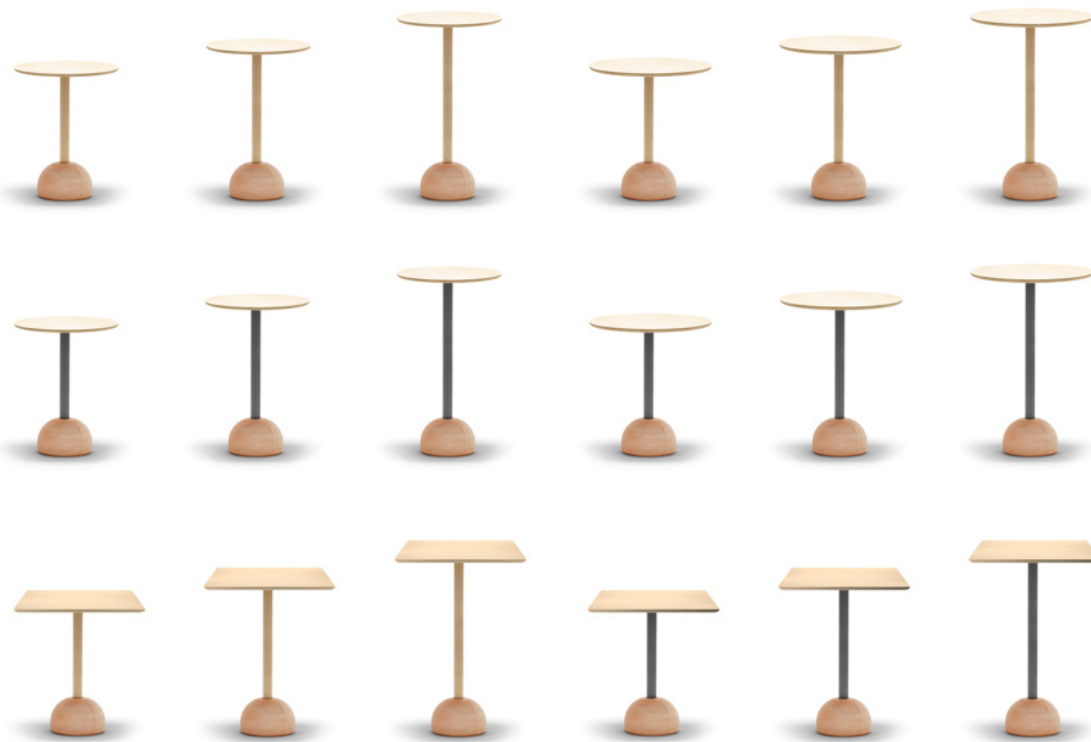

Pots

