Atal Bistrot Table

Design by Form Us With Love

760 x Ø 600 mm



The Atal bistrot table has a central metal leg. The top can be covered of solid oak or laminated. Round or square, it is available in several sizes.

CATEGORY:

Table

ENVIRONMENT:

Indoor

APPLICATIONS:

- CHR
- Public
- Office

WEIGHT: 13,2 kg

MATERIALS:

Top 22mm solid oak multi-ply or laminate. Legs: Metal.

MADE TO ORDER: Finishes page 2

ACCESSORIES: No

ASSEMBLED PRODUCT: Yes

REMOVABLE PRODUCT: No

CLEANING AND CARE INSTRUCTIONS:

Dry cloth. To avoid aerosol and spray products with silicone.

DOWNLOADS:

3D and 2D files are available at alki.fr – images bank section.

DIMENSIONS :

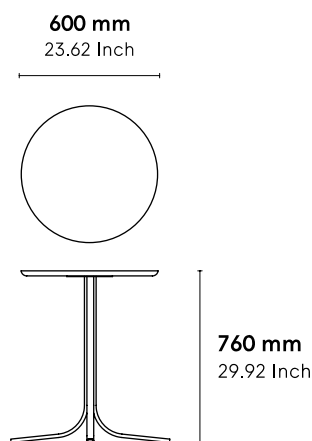

Non contractual document - modifiable without previous notice.

Finishes

Wood



Black RAL 9004

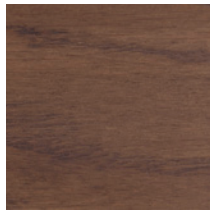

White RAL 9010

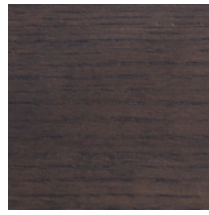

Green RAL 6020



Orange RAL 8001

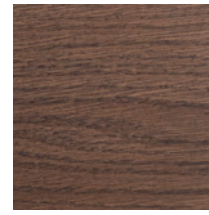

Oxide RT 8102



Hot Grey EWA02

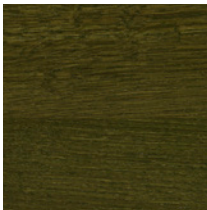

Black RAL 9004

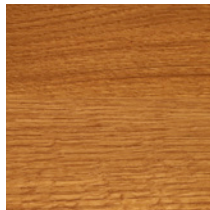

White RAL 9010

Metal Frames

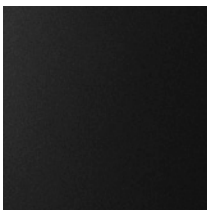

Black RAL 9004

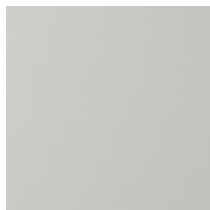

White RAL 9010



Green RAL 6020



Orange RAL 8001

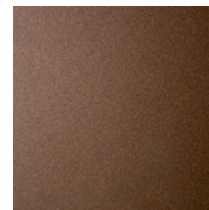

Oxide RT 8102

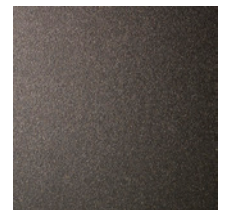

Hot Grey EWA02

Fenix Technical Surface

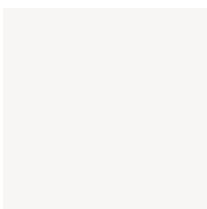

White 0032



Black 0720

SEATING

- Chairs
- Lounge Chairs
- Stools

TABLES

- Bistro Tables

Chairs



Stools



Bistro Tables

