

Heldu workig table + storage

Design by Iratzoki Lizaso

760 x 1920 x 1350 mm



The Heldu range is available to furnish office spaces. Different modules of table surfaces can be joined together to create a variable length platform. Mobile partitions enable workstations to be laid out quickly according to working requirements.

CATEGORY:

Working space

ENVIRONMENT:

Indoor

APLICATIONS:

- CHR
- Public
- Office
- Home

WEIGHT: 105 kg

MATERIALS:

Product delivered assembled but not connected(table/shelve), in 3 packages. **Table co-working Heldu** — Table: Solid oak top (3 ply, 22 mm thickness). One cable passing system in oak with leather.

Heldu Storage — Plywood structure , oak veneer. Doors and pannels : oak veneer/ particle board. Inside shelve.

MADE TO ORDER: Finishes page 2

ACCESSORIES: No

ASSEMBLED PRODUCT: Yes

REMOVABLE PRODUCT: No

CLEANING AND CARE INSTRUCTIONS:

Dry cloth. To avoid aerosol and spray products with silicone.

DOWNLOADS:

3D and 2D files are available at alki.fr – images bank section.

DIMENSIONS :

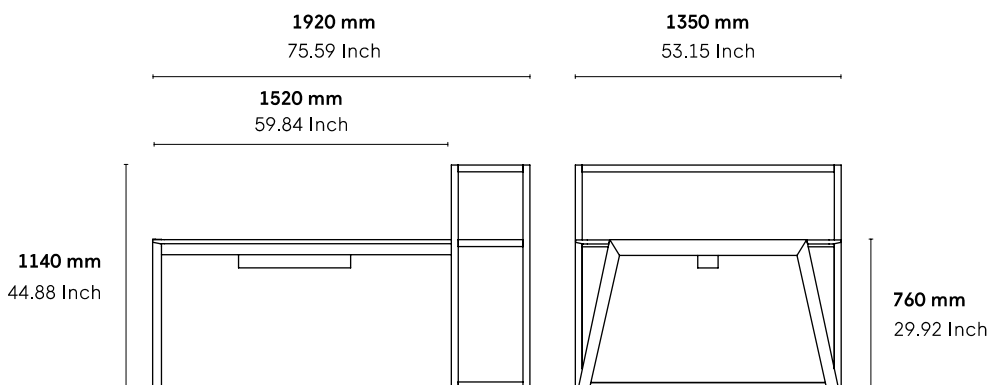

Non contractual document - modifiable without previous notice.

Finishes

Wood



Natural Oak

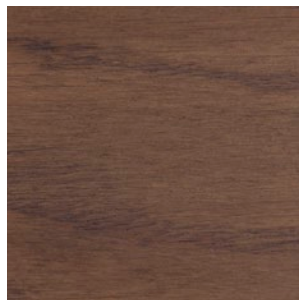

Ash Grey Oak



Tourbe Oak



Carbon Oak



Walnut Stained Oak



White Stained Oak

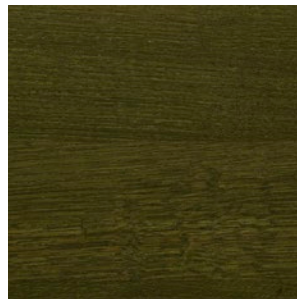

Green Z1 Oak Stain

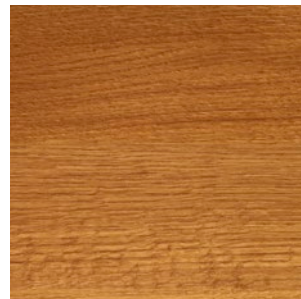

Orange 19 Oak Stain

Electrification

Électrification Bachmann



Cable pass system



Hidden system



Heldu Collection

Design by Iratzoki Lizaso

SEATING

Chairs
Benches
Stools

Chairs



TABLES

Desk Tables
Meeting Tables
Bench Tables
High Working Tables
Dining Tables
High Dining Tables
Low Tables

Desk Tables



Meeting Tables



Dining Tables



High Dining Tables



ORGANIZATION

Storage & Shelving
Drawers
Dividers
Props & Accessories

High Working Tables



Bench Tables



Bench Tables



Low Tables



Storage & Shelving



Drawers



Dividers



Props & Accessories

