

---

# Heldu rectangular table

760 x 1300/1850 x 850 mm

Design by Jean Louis Iratzoki



---

**The Heldu table has a solid oak construction. Solid oak or laminated top. It is available in four different sizes. Three of these can be extensibles.**

**CATEGORY:**

Table

**ENVIRONMENT:**

Indoor

**APLICATIONS:**

- CHR
- Public
- Office

**WEIGHT:** 45 kg

**MATERIALS:**

Solid oak construction. Solid oak top (3 ply, 22 mm thickness) or laminate top. 550 mm foldable extension, in solid oak or laminate top.

**MADE TO ORDER:** Finishes and upholsteries, page 2

**ACCESSORIES:** No

**ASSEMBLED PRODUCT:** Yes

**REMOVABLE PRODUCT:** No

**CLEANING AND CARE INSTRUCTIONS:**

Dry cloth. To avoid aerosol and spray products with silicone.

**DOWNLOADS:**

3D and 2D files are available at [alki.fr](http://alki.fr) – images bank section.

---

**DIMENSIONS :**

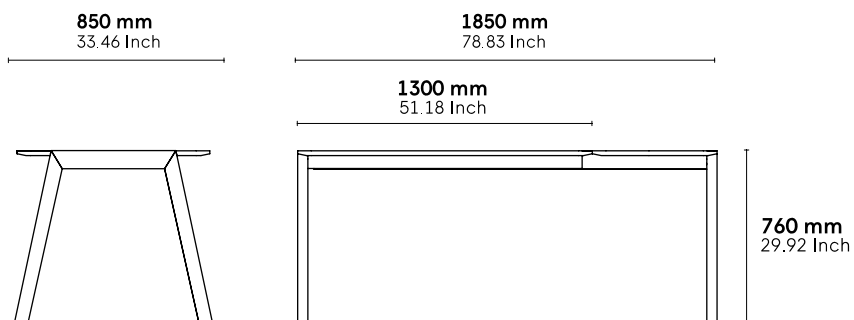

Non contractual document - modifiable without previous notice.

---

# Finishes

## Wood

---



Natural Oak

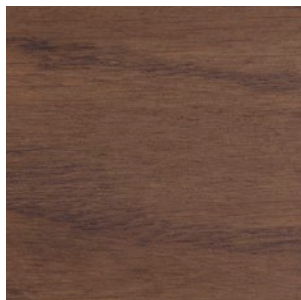

Ash Grey Oak

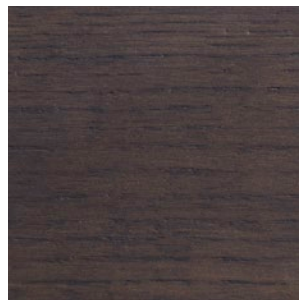

Tourbe Oak



Carbon Oak

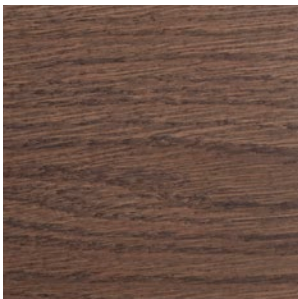

Walnut Stained Oak



White Stained Oak

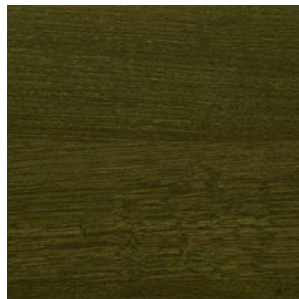

Green Z1 Oak Stain

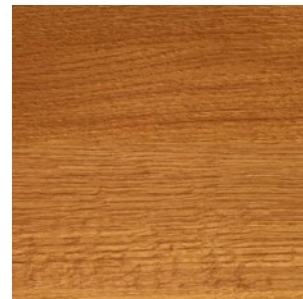

Orange 19 Oak Stain

## Fenix Technical Surface

---

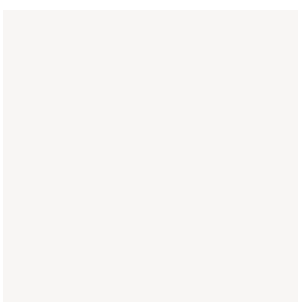

White 0032

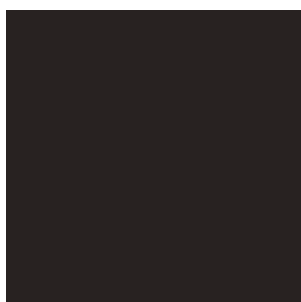

Black 0720

# Heldu Collection

Design by Iratzoki Lizaso

## SEATING

Chairs  
Benches  
Stools

### Chairs



### Stools

### Benches

## TABLES

Desk Tables  
Meeting Tables  
Bench Tables  
High Working Tables  
Dining Tables  
High Dining Tables  
Low Tables

### Desk Tables

### Meeting Tables

### Dining Tables

### High Dining Tables



### High Working Tables

### Bench Tables



### Bench Tables



### Low Tables

### Storage & Shelving

### Drawers



### Dividers

### Props & Accessories

