

# Laia high

1080 x 1300 x 1300 mm

Design by Jean Louis Iratzoki



The Laia table is also available in high version. With a solid oak construction, it is perfect to have a breakfast or to snack throughout the day.

**CATEGORY:**

Table

**ENVIRONMENT:**

Indoor

**APPLICATIONS:**

- CHR
- Public
- Office

**WEIGHT:** 40 kg

**MATERIALS:**

Legs in solid oak. Top in 16mm multi-ply + 4 solid mitre-cut edges, oak veneer 2 sides.

**MADE TO ORDER:** Finishes page 2

**ACCESSORIES:** No

**ASSEMBLED PRODUCT:** Yes

**REMOVABLE PRODUCT:** No

**CLEANING AND CARE INSTRUCTIONS:**

Dry cloth. To avoid aerosol and spray products with silicone.

**DOWNLOADS:**

3D and 2D files are available at [alki.fr](http://alki.fr) – images bank section.

**DIMENSIONS :**

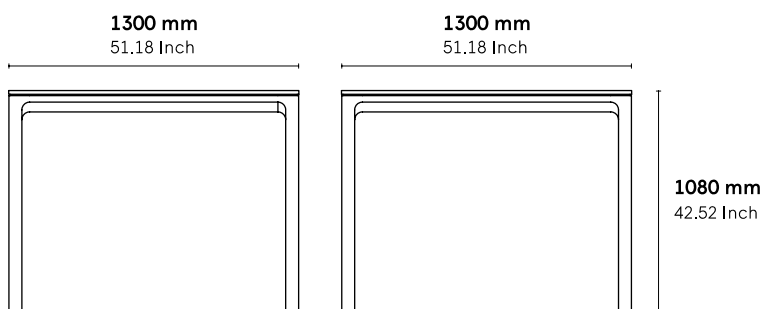

Non contractual document - modifiable without previous notice.

---

# Finishes

## Wood

---



Natural Oak



Ash Grey Oak



Tourbe Oak



Carbon Oak



Walnut Stained Oak



White Stained Oak



Green Z1 Oak Stain



Orange 19 Oak Stain

# Laia Collection

Design by Jean Louis Iratzoki

## SEATING

- Chairs
- Working Chairs
- Meeting Chairs
- Benches
- Stools

## TABLES

- Desk Tables
- Meeting Tables
- High Working Tables
- Dining Tables
- High Dining Tables
- Low Tables

### Chairs



### Stools



### Working Chairs



### Meeting Chairs



### Benches



### Desk Tables

### Meeting Tables

### High Working Tables



### Dining Tables



### High Dining Tables

### Low Tables

