Heldu High table

1080 x 1600 x 800 mm

Design by Iratzoki Lizaso



The Heldu table is also available in high version. With a solid oak construction, it is perfect to have a breakfast or to snack throughout the day.

CATEGORY:

High table

ENVIRONMENT:

Indoor

APLICATIONS:

- CHR
- Public
- Office

WEIGHT: 42,5 kg

MATERIALS:

Solid oak construction. Solid oak top (3 ply, 22 mm thickness) or laminate top.

MADE TO ORDER: Finishes to be specified.

ACCESSORIES: No

ASSEMBLED PRODUCT: Yes

REMOVABLE PRODUCT: No

CLEANING AND CARE INSTRUCTIONS:

Dry cloth. To avoid aerosol and spray products with silicone.

DOWNLOADS:

3D and 2D files are available at alki.fr – images bank section.

DIMENSIONS :

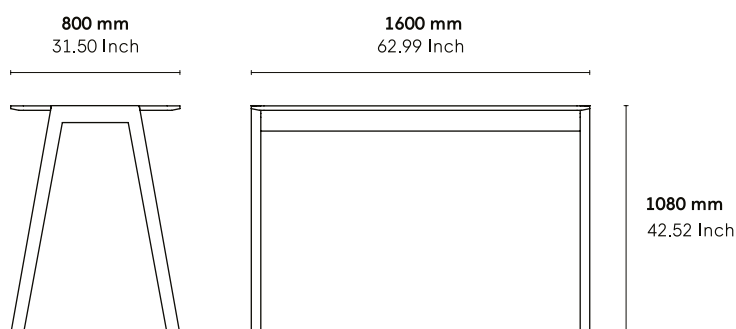

Non contractual document - modifiable without previous notice.

Heldu Collection

Design by Jean Louis Iratzoki

SEATING

Chairs
Benches
Stools

Chairs



TABLES

Desk Tables
Meeting Tables
Bench Tables
High Working Tables
Dining Tables
High Dining Tables
Low Tables

Desk Tables



Meeting Tables



Dining Tables



High Dining Tables



ORGANIZATION

Storage & Shelving
Drawers
Dividers
Props & Accessories

High Working Tables



Bench Tables



Bench Tables



Low Tables



Storage & Shelving



Drawers



Dividers



Props & Accessories

