

Table bistrot Atal

900 x Ø 700 mm

Design by Form Us With Love



Les tables bistrots Atal sont composées d'un pied central métallique et d'un plateau qui peut être rond ou carré, en chêne massif ou stratifié.

CATÉGORIE :

Table

ENVIRONNEMENT :

Indoor

APPLICATIONS :

- CHR
- Public
- Office

POIDS : 17,8 kg

MATÉRIAUX :

Plateau : épaisseur 22mm , panneau chêne massif en triplis ou stratifié. Piètement : Piètement métal.

A LA COMMANDE : Finitions voir page 2

ACCESSOIRES : Non

PRODUIT ASSEMBLÉ : Oui

PRODUIT DEMONTABLE : Non

ENTRETIEN :

Uniquement microfibre à peine humide + sécher au chiffon. Ne pas utiliser de produits qui contiennent du silicone.

TÉLÉCHARGEMENTS :

Fichiers 3D et DWG sont disponibles sur alki.fr section banque d'images.

DIMENSIONS :

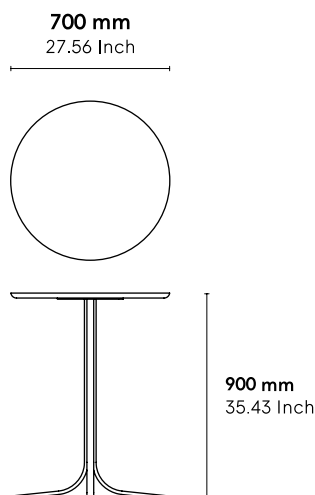

Document non contractuel, modifiable sans préavis.

Finitions

Wood



Black RAL 9004

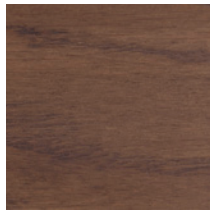

White RAL 9010

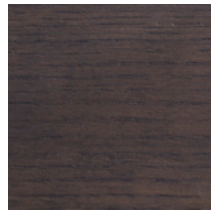

Green RAL 6020



Orange RAL 8001

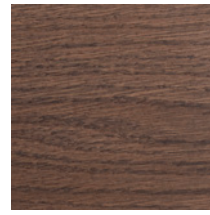

Oxide RT 8102



Hot Grey EWA02

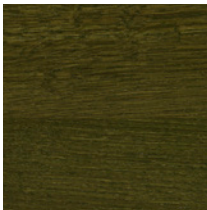

Black RAL 9004

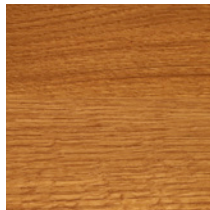

White RAL 9010

Metal Frames

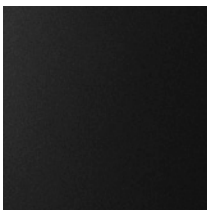

Black RAL 9004

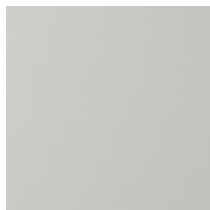

White RAL 9010



Green RAL 6020



Orange RAL 8001

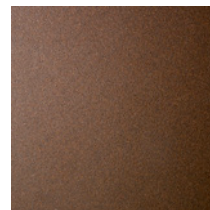

Oxide RT 8102

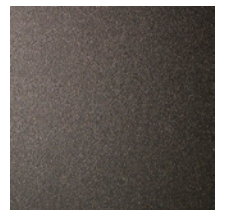

Hot Grey EWA02

Fenix Technical Surface

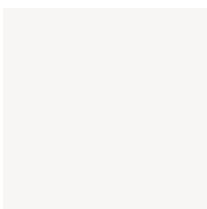

White 0032



Black 0720

SEATING

- Chairs
- Lounge Chairs
- Stools

TABLES

- Bistro Tables

Chairs



Stools



Bistro Tables

