

Table bistrot Lur

1080 x Ø 700 mm

Design by Iratzoki Lizaso



Piètement
métal



Piètement
chêne



La collection Lur est née de la collaboration entre Alki et la poterie voisine Goicoechea. Elle associe nos savoir-faire et matériaux de prédilection, le bois et la terre cuite. Les tables bistrot LUR sont disponibles en 3 hauteurs et différentes dimensions.

CATÉGORIE :

Table

ENVIRONNEMENT :

Indoor

APPLICATIONS :

- CHR
- Public
- Office
- Home

POIDS : 29 kg

MATÉRIAUX :

Piètement métal, ou avec forreau bois et cache pied en terre cuite. Plateau épaisseur 22 mm en triplis chêne massif ou stratifié fenix avec alaises en chêne massif, support CP. Usage intérieur exclusif.

A LA COMMANDE : Finitions voir page 2

ACCESSOIRES : Non

PRODUIT ASSEMBLÉ : Oui

PRODUIT DEMONTABLE : Non

ENTRETIEN :

Uniquement microfibre à peine humide + sécher au chiffon. Ne pas utiliser de produits qui contiennent du silicone.

TÉLÉCHARGEMENTS :

Fichiers 3D et DWG sont disponibles sur alki.fr section banque d'images.

DIMENSIONS :

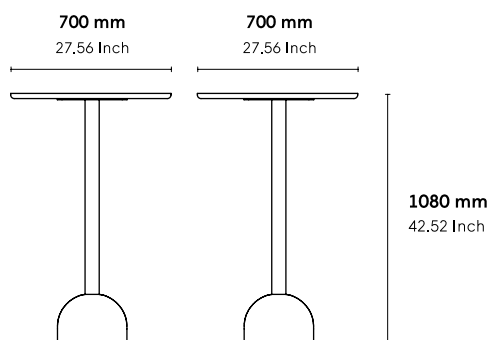

Document non contractuel, modifiable sans préavis.

Finitions

Wood



Natural Oak

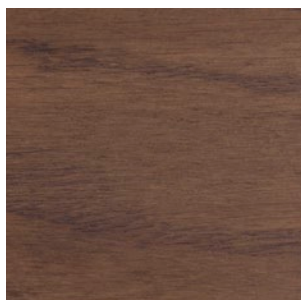

Ash Grey Oak

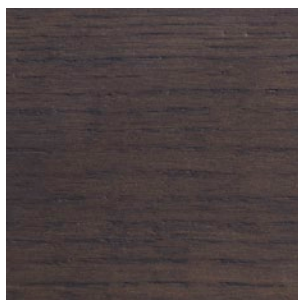

Tourbe Oak



Carbon Oak

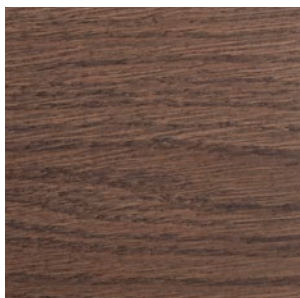

Walnut Stained Oak



White Stained Oak

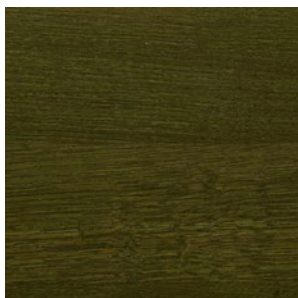

Green Z1 Oak Stain

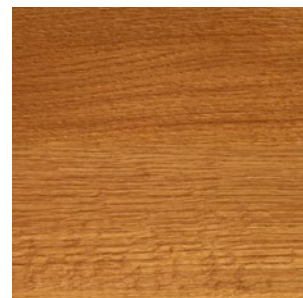

Orange 19 Oak Stain

Fenix Technical Surface

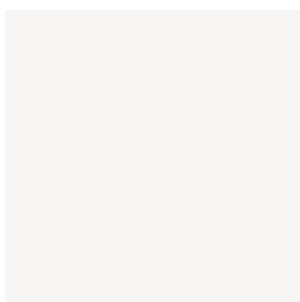

White 0032



Black 0720

Terracotta

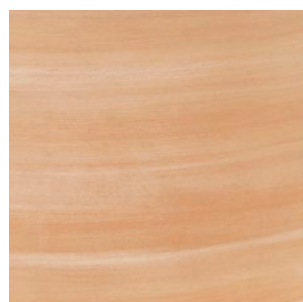

Lur Collection

Design by Iratzoki Lizaso

TABLES

Bistrot Tables

Bistro Tables

ORGANIZATION

Pots

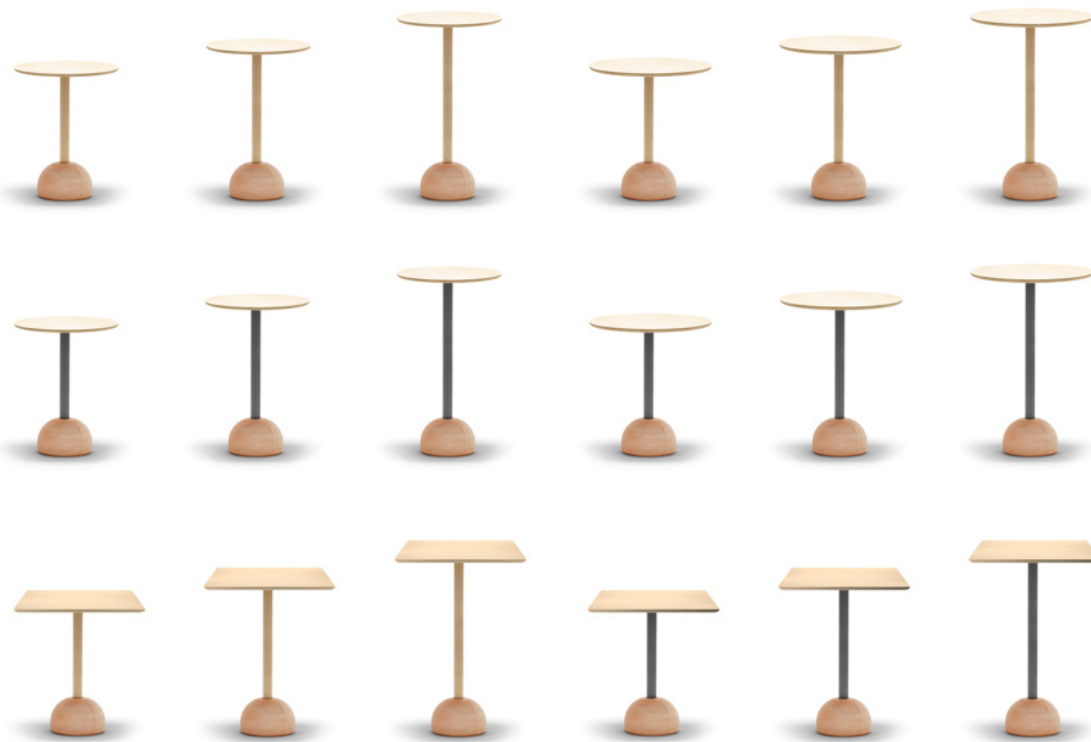

Pots

