

Emea extendable table

760 x 2200/3100 x 950 mm

Design by Jean Louis Iratzoki



The Emea collection, featuring oak wood, showcases the company's technical expertise. The Emea table is available in three sizes, but also with two extensions. It is a perfect illustration of the idea of solid wood. Its different components appear to be carved from a single block.

CATEGORY:

Table

ENVIRONMENT:

Indoor

APPLICATIONS:

- CHR
- Public
- Office

WEIGHT: 99 kg

MATERIALS:

Legs in solid oak. And metal reinforcement for the biggest sizes.
Top in 38mm multi ply + 4 underpads massive cuts miter, oak veneer 2 sides.

MADE TO ORDER: Finishes and upholsteries, page 2

ACCESSORIES: No

ASSEMBLED PRODUCT: Yes

REMOVABLE PRODUCT: No

CLEANING AND CARE INSTRUCTIONS:

Dry cloth. To avoid aerosol and spray products with silicone.

DOWNLOADS:

3D and 2D files are available at alki.fr – images bank section.

EMEA COLLECTION:



DIMENSIONS:

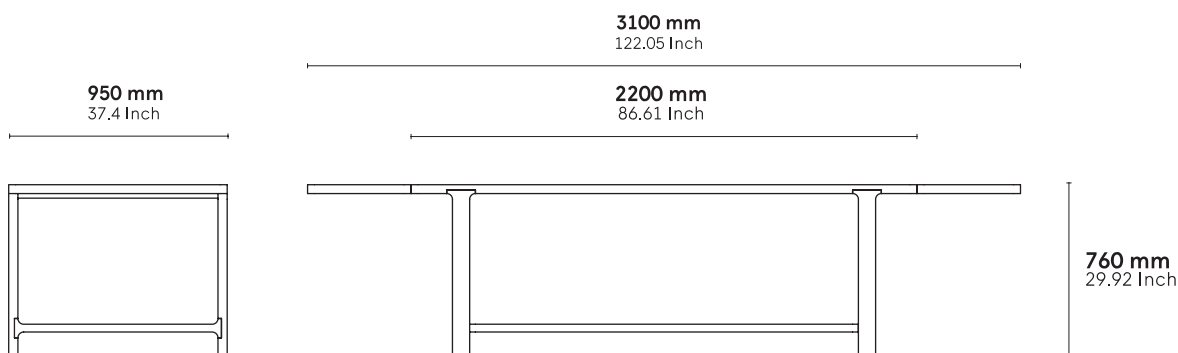

Non contractual document - modifiable without previous notice.

Finishes

Wood



Natural Oak



Ash Grey Oak



Tourbe Oak



Carbon Oak



Walnut Stained Oak



White Stained Oak